

Feats

- i Pb free product—RoHS compliant
- i Low power consumption, High efficiency
- i Reliable and rugged
- i Long life – solid state reliability
- i Radiant angle: 70°

Package Dimension

Notes

1. All dimensions are in millimeters.
2. Tolerance is ± 0.10 mm unless otherwise noted
3. Specifications are subject to change without notice.

Abolt Maimm RaingsafTa=25 W

Parameter	MAX.	Unit
Power Dissipation	150	mW
Continuous Forward Current	100	mA
Peak Forward Current ^{*3}	1.0	A
Reverse Voltage	5	V
Electrostatic Discharge (HBM ^{*5})	2000	V
Moisture Sensitivity Level ¹	5a	
Operating Temperature	-40 to + 85	
Storage Temperature	-40 to + 100	
IR Reflow Temperature ^{*4}	260 for 10 Seconds MAX.	

1. **Sbng** Ö

LIGHT

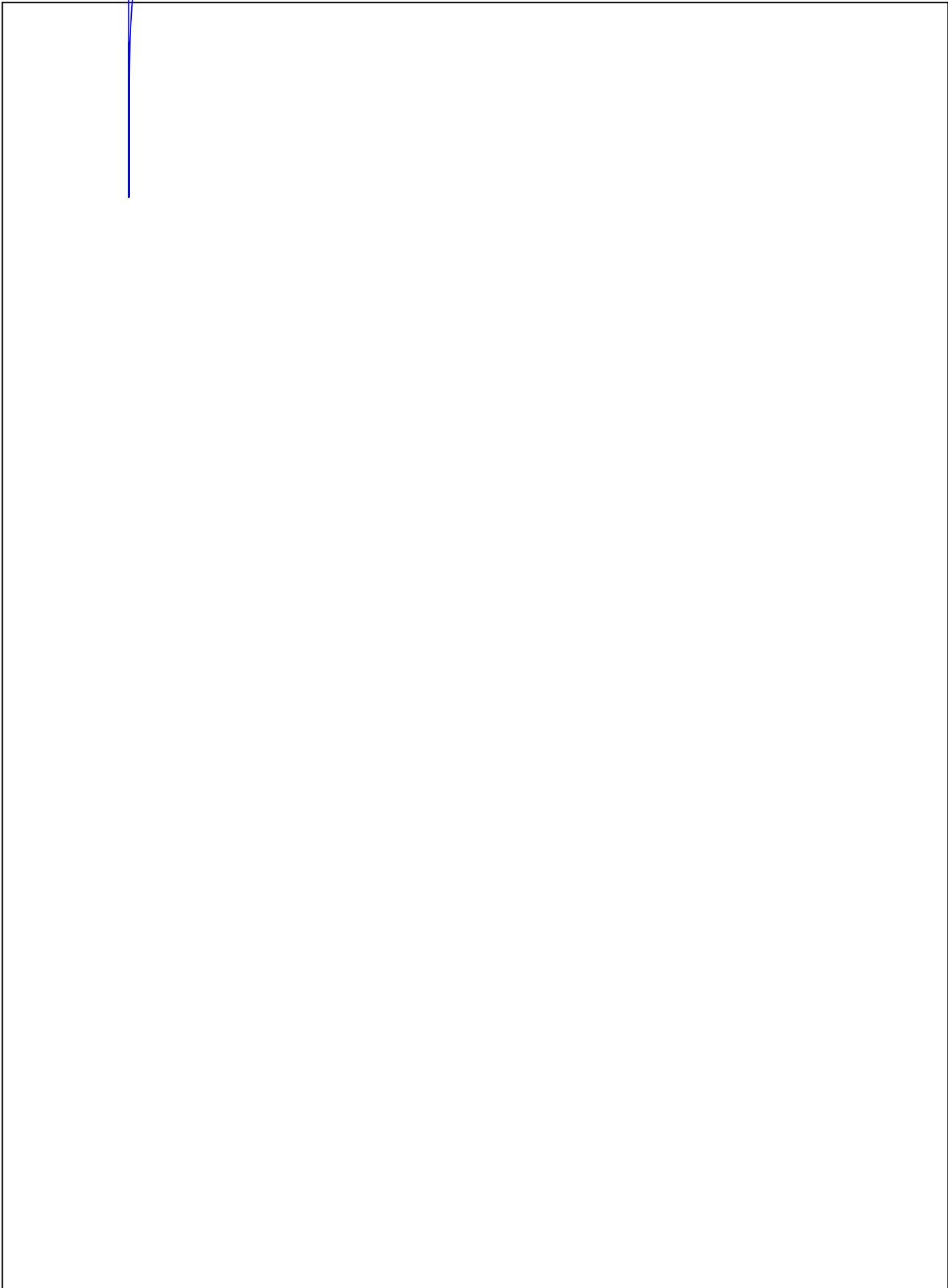

LIGHT



Typical Electrical / Optical Characteristics
(25 W Ambient Temp unless otherwise noted)

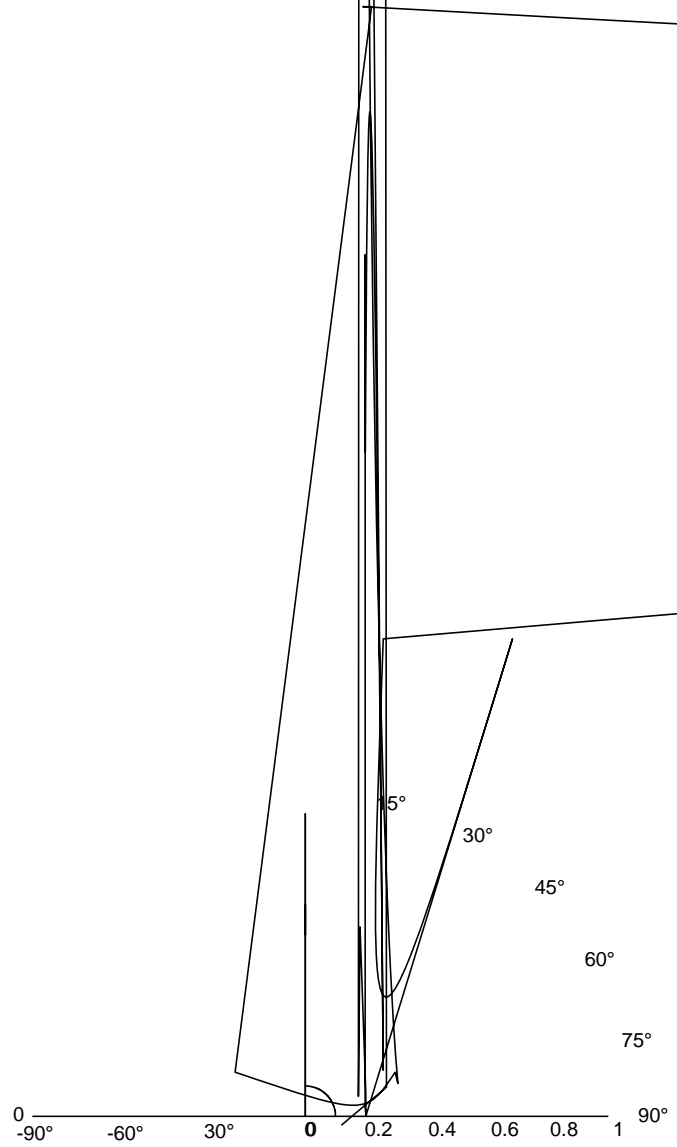



000

Note: Tolerance unless mentioned is ± 0.1 mm; Unit = mm

000

