

# **SL-T2016IRPTB009-L75**

## **DATA SHEET**

SPEC. NO. : SZ21073101  
DATE : 2021/07/31  
REV. : A/1

Approved By:

Checked By:

Prepared By:



Light

LIGHT ELECTRONICS CO. LTD.

LIGHT for dehumidification.

### 2. Caution in ESD:

Static Electricity and surge damages the LED. It is recommend to use a wrist band or anti-electrostatic glove when handling the LED. All devices, equipment and machinery must be properly grounded.

### 3. Pulse Forward Current:

Pulse Width 0.1ms and duty 10%.

## Typical Product Characteristics (Ta=25 )-Emitter

Characteristics	Symbol	Min.	Typ.	Max.	Unit	Test condition
Forward Voltage	$V_F$	-	2.0	2.5	V	$I_F=7mA$
Reverse Current	$I_R$	-	-	10	$\mu A$	$V_R=2V$
Center Wavelength	$\lambda_P$	-	940	-	nm	$I_F=7mA$
Spectrum Width of Half Value	$D_P$	-	5	-	nm	$I_F=7mA$

**Note:** Tolerance of Forward Voltage:  $\pm 0.1V$ .

## Typical Product Characteristics (Ta=25 )-Detector

Characteristics	Symbol	Min.	Typ.	Max.	Unit	Test condition
Collector Emitter Breakdown Voltage	$BV_{CEO}$	85	-	-	V	$I_C=100\mu A$ $L^*=0$
Emitter Collector Breakdown Voltage	$BV_{ECO}$	8.2	-	-	V	$I_E=10\mu A$ $L^*=0$
Collector Emitter Dark Current	$I_{CEO}$	-	2	30	nA	$V_{CE}=20V, L^*=0$ Fig. 2

**Note:**  $L^*=0$  (zero light condition)



Optical Characteristics (Ta=25°C)

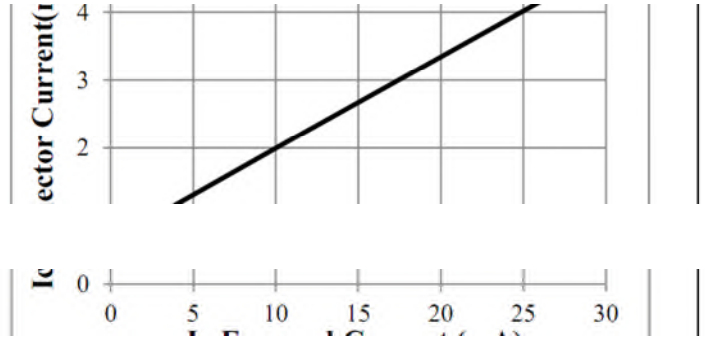
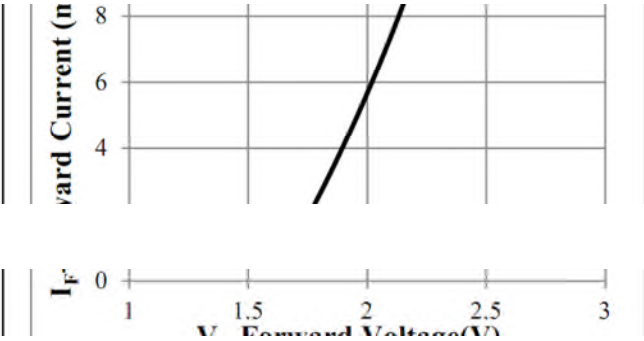

Note:  $V_{CE}=5V$ ,  $D=1\text{ms}$ , Pulse width 0.1ms  
5% Duty Cycle

3 Forward Voltage vs. Ambient Temperature

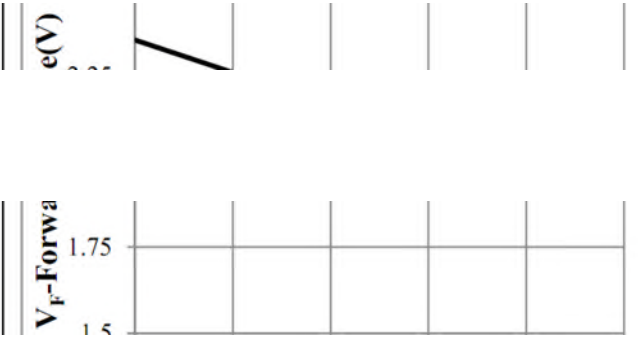

4 Collector Current vs. Ambient Temperature

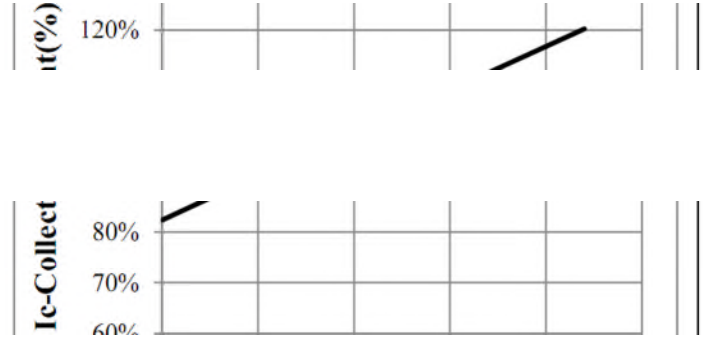

**Output Current Test Condition (Ta=25°C)**

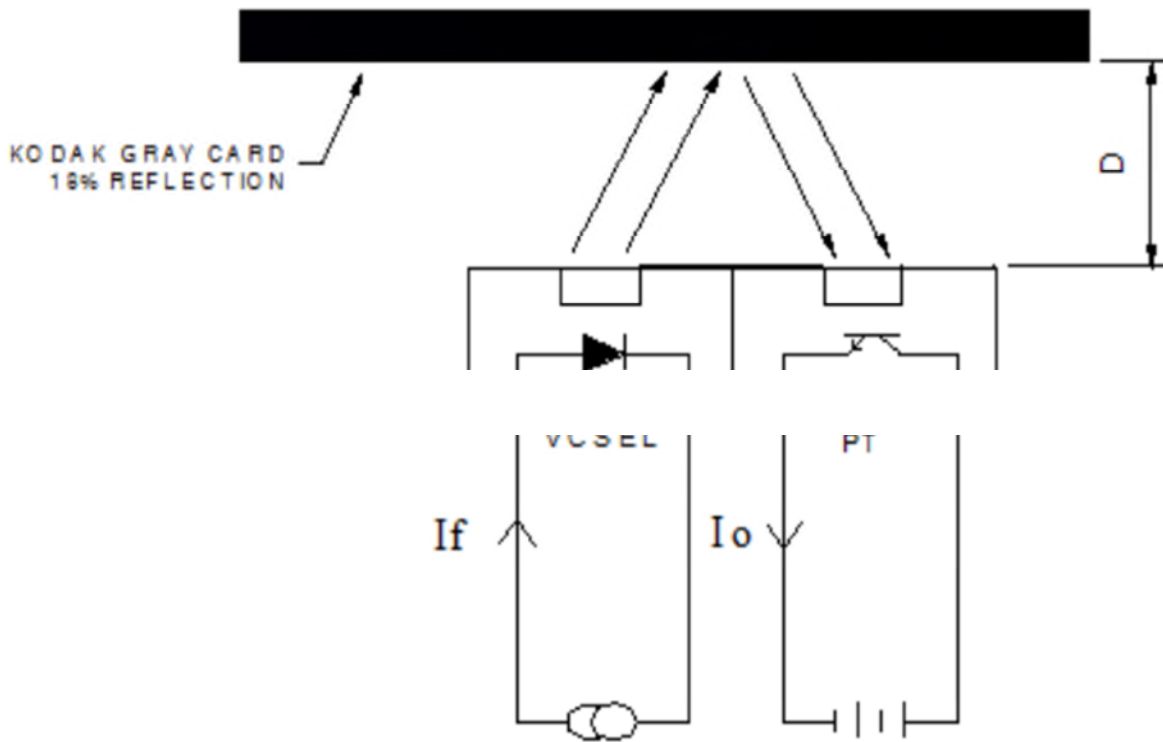

Fig.1 : Test Condition: D = 1mm 18% Gray Card,  $I_F=7$  mA,  $V_{CE} = 5V$ , Pulse width 0.1ms, 5% Duty Cycle

**Dark Current Test Condition (Ta=25°C)**

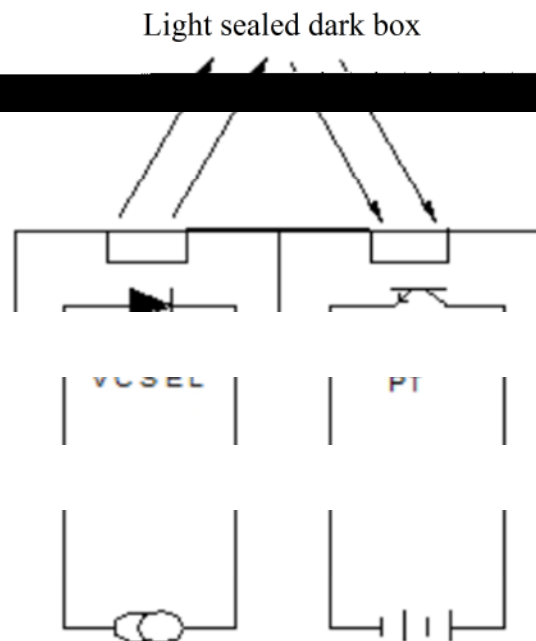
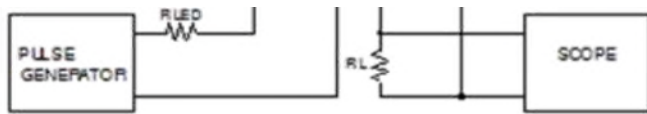
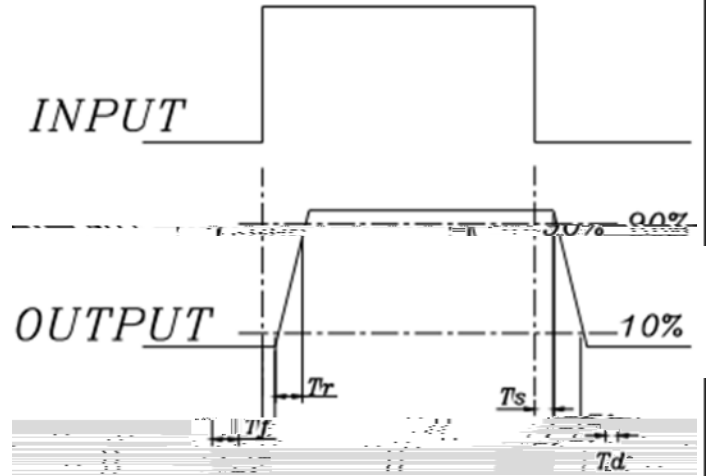
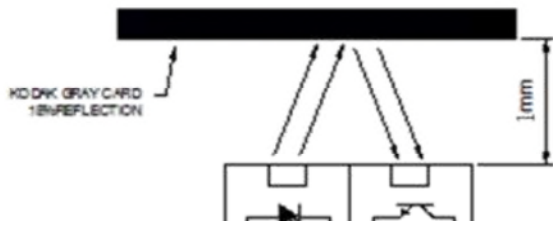

Fig. 2: Test Condition:  $I_{LED}=9$  mA,  $V_{CE} = 5V$ , Pulse width 0.1ms, 5% Duty Cycle

Program Time Test Conditions (T=25°C)



Label Explanation

LIGHT Universal Label  
(Reel Label)

Customer Defined Label  
(Aluminum Moisture Proof Bag Label)

<b>LIGHT</b>		
Light Electronics CO., LTD.		
MODEL NAME: _____	 LOT NO.: _____	
QUANTITY: _____		
BIN: _____		
PACKING DATE: _____		
REMARKS: _____		

<b>LIGHT</b>		
Light Electronics CO., LTD.		
MODEL NAME: _____	 LOT NO.: _____	
QUANTITY: _____		
BIN: _____		
PACKING DATE: _____		
CUSTOMER P/N: _____		

Reel Dimensions

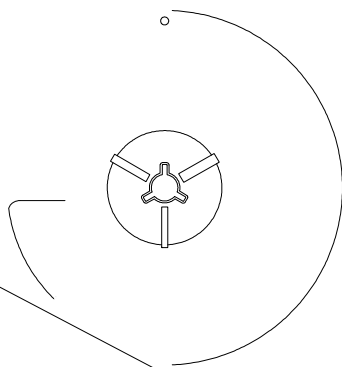

Note: Tolerance, unless mentioned is  $\pm 0.2$ mm; Unit = mm.





0...JI...ND... 2... Cou...es... Re...er...ow... Co...n...o...n... for... es...o... Price

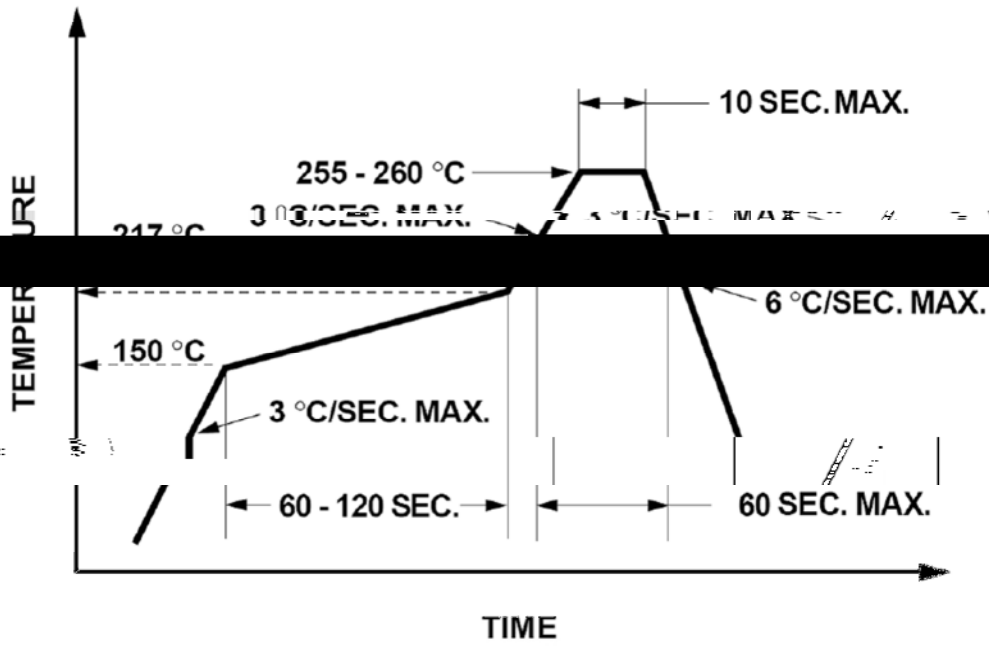

1. Reflow soldering should not be done more than two times.
2. When soldering, do not put stress on the LEDs during heating.

**Soldering iron**

1. When hand soldering, the temperature of the iron must less than 300°C for 3 seconds.
2. The hand solder should be done only once.

**Repairing**

Repair should not be done after the LEDs have been soldered. When repairing is unavoidable, a double-head soldering iron should be used (as below figure). It should be confirmed beforehand whether the characteristics of LEDs will or will not be damaged by repairing.

